

Kempact Pulse™ | 3000

KempactCool™ | 10

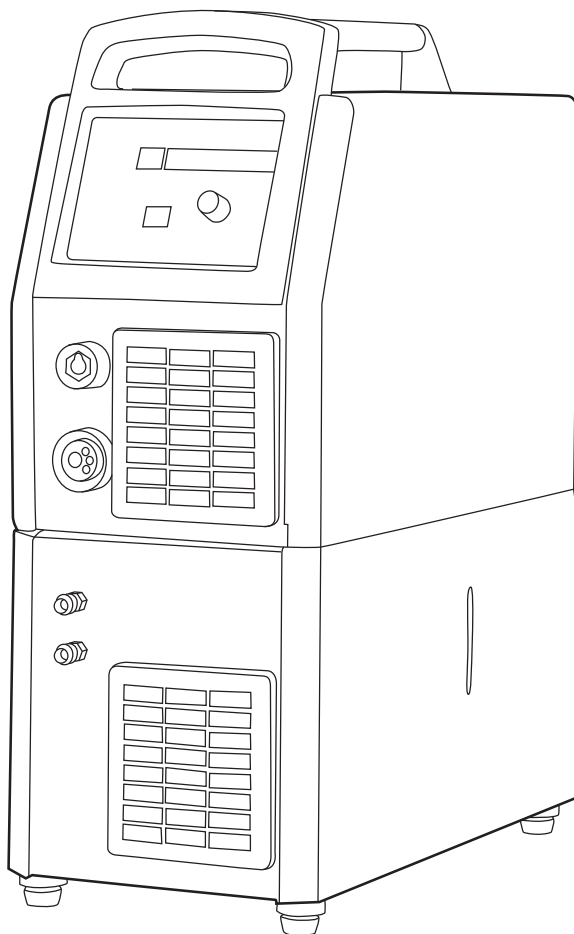

Operating manual • English **EN**

Käyttöohje • Suomi **FI**

Bruksanvisning • Svenska **SV**

Bruksanvisning • Norsk **NO**

Brugsanvisning • Dansk **DA**

Gebrauchsanweisung • Deutsch **DE**

Gebruiksaanwijzing • Nederlands **NL**

Manuel d'utilisation • Français **FR**

Manual de instrucciones • Español **ES**

Instrukcja obsługi • Polski **PL**

Инструкции по эксплуатации • По-русски **RU**

操作手册 • 中文 **ZH**

Manuale di istruzioni • Italiano **IT**

OPERATING MANUAL

English

CONTENTS

1. PREFACE	3
1.1 General.....	3
1.2 Product introduction.....	3
2. BEFORE YOU START USING THE UNIT	3
2.1 Unpacking	3
2.2 Placement of the unit.....	3
2.3 Serial number.....	3
2.4 Distribution network	4
2.5 Connection to the mains supply.....	4
2.6 Ground cable.....	4
2.7 DuraTorque™ 400, 4 wheel wire feed mechanism	4
2.8 Installation of welding gun.....	5
2.9 Mounting and locking of wire reel	5
2.10 Automatic wire feed to gun.....	6
2.11 Adjustment of pressure	6
2.12 Adjustment of tightness of spool brake	6
2.13 Shielding gas.....	7
2.14 Cooling unit (Kempactcool 10)	8
3. OPERATION	9
3.1 Main switch and signal lights	9
3.2 To select polarity for welding	9
3.2.1 Changing the polarity.....	9
3.3 Panel	10
3.3.1 Choosing start switch function	10
3.3.2 Choosing the welding method	10
3.3.3 Selecting 1-MIG/Pulse MIG synergy curves	11
3.3.4 Adjustments, display and weld data	12
3.3.5 Timer	13
3.3.6 Adjustment of welding dynamics	13
3.3.7 Remote control	13
3.3.8 MIG extra functions	14
3.3.9 Use of gas test.....	14
3.3.10 Testing wire feed	14
3.3.11 Memory channels, MEMORY	15
3.3.12 SETUP.....	16
3.3.13 Error codes.....	17
3.4 Cooling unit operation (KempactCool 10).....	18
4. MAINTENANCE	18
4.1 Daily maintenance.....	18
4.2 Regular maintenance	18
5. DISPOSAL OF THE MACHINE	18
6. ORDERING NUMBERS	19
7. TECHNICAL DATA	20

1. PREFACE

1.1 GENERAL

Congratulations on your choice of the Kempact Pulse™ series power source. Reliable and durable, Kemppe products are affordable to maintain, and they increase your work productivity.

This user manual contains important information on the use, maintenance, and safety of your Kemppe product. The technical specifications of the device can be found at the end of the manual. Please read the manual carefully before using the equipment for the first time. For your safety and that of your working environment, pay particular attention to the safety instructions in the manual.

For more information on Kemppe products, contact Kemppe Oy, consult an authorised Kemppe dealer, or visit the Kemppe Web site at www.kempe.com.

The specifications presented in this manual are subject to change without prior notice.

Important notes

Items in the manual that require particular attention in order to minimise damage and personal harm are indicated with the **'NOTE!'** notation. Read these sections carefully and follow their instructions. Please also read the safety instructions in this manual and respect them.

Disclaimer

While every effort has been made to ensure that the information contained in this guide is accurate and complete, no liability can be accepted for any errors or omissions. Kemppe reserves the right to change the specification of the product described at any time without prior notice. Do not copy, record, reproduce or transmit the contents of this guide without prior permission from Kemppe.

1.2 PRODUCT INTRODUCTION

The Kempact Pulse 3000 is a compact MIG inverter suitable for repair and installation use, and for light and medium industrial use.

2. BEFORE YOU START USING THE UNIT

2.1 UNPACKING

The equipment is packed in durable packages, designed specially for it. Nevertheless, before using the equipment, always make sure it was not damaged during transport. Also check that you have received what you ordered and it is accompanied by the appropriate instructions.

NOTE! The packaging material is suitable for recycling.

2.2 PLACEMENT OF THE UNIT

Place the unit on a horizontal, solid, and clean surface. Shield it from heavy rain and scorching sun. Make sure that cooling air circulates freely.

2.3 SERIAL NUMBER

The serial number of the unit is marked on its rating plate. The serial number makes it possible to trace product manufacturing series. You might need the serial number when placing spare parts orders or when planning maintenance.

2.4 DISTRIBUTION NETWORK

All regular electrical devices without special circuits generate harmonic currents into distribution network. High rates of harmonic current may cause losses and disturbance to some equipment.

Kempact Pulse 3000:

WARNING: This equipment does not comply with IEC 61000-3-12. If it is connected to a public low voltage system, it is the responsibility of the installer or user of the equipment to ensure, by consultation with the distribution network operator if necessary, that the equipment may be connected.

2.5 CONNECTION TO THE MAINS SUPPLY



The Kempact Pulse 3000 is delivered with a five metre mains cable without a plug. Installation of the plug should be carried out only by a competent electrician. For fuse and cable sizes, see the technical data in the end of this document.

2.6 GROUND CABLE

Fasten the earth clamp of the return current cable carefully, preferably direct onto the piece to be welded. The contact surface of the earth clamp should always be as large as possible.

Clean the fastening surface of paint and rust. Use at least two 35 mm² cables. Thinner cross sectional areas may cause the connectors to overheat.

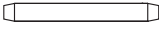
2.7 DURATORQUE™ 400, 4 WHEEL WIRE FEED MECHANISM

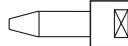
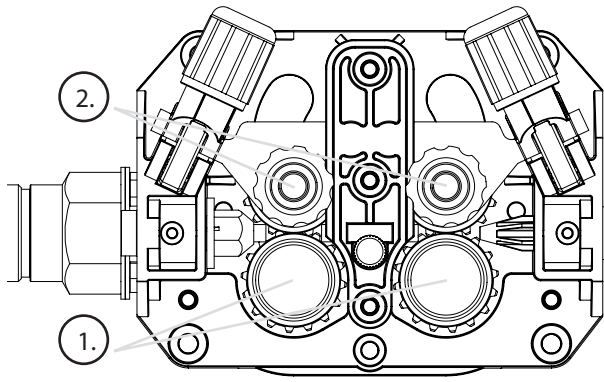
Wire guide tubes							
Ss, Al, Fe, Mc, Fc	∅ 0.6 – 1.6 mm	→	∅ 2.5/64 mm, W000762, silver, plastic	→	∅ 2.5/33 mm, W000956, silver, plastic	→	∅ 2.0 mm, W000624, plastic
	∅ 1.6 – 2.4 mm	→	∅ 3.5/64 mm, W001430, silver, plastic	→	∅ 3.5/33 mm, W001431, silver, plastic	→	∅ 3.5 mm, W001389, plastic
Fe, Mc, Fc	∅ 0.6 – 0.8 mm	→	∅ 1.0/67 mm, W001432, white, steel	→	∅ 2.0/33 mm, W001435, orange, steel	→	∅ 2.0 mm, W000624, plastic
	∅ 0.9 – 1.6 mm	→	∅ 2.0/64 mm, W001433, orange, steel			→	∅ 3.5 mm, W001389, plastic
	∅ 1.6 – 2.4 mm	→	∅ 4.0/63 mm, W001434, blue, steel	→	∅ 4.0/33 mm, W001436, blue, steel	→	∅ 3.5 mm, W001391, brass
							
							

Wire feed rolls				
	ø mm	colour	drawing	pressing
Fe, Ss, Al, V-groove	0.6	pale grey	W001045	W001046
	0.8/0.9	white	W001047	W001048
	1.0	red	W000675	W000676
	1.2	orange	W000960	W000961
	1.4	brown	W001049	W001050
	1.6	yellow	W001051	W001052
	2.0	grey	W001053	W001054
	2.4	black	W001055	W001056
Fe, Fc, Mc, knurled	1.0	red	W001057	W001058
	1.2	orange	W001059	W001060
	1.4/1.6	yellow	W001061	W001062
	2.0	grey	W001063	W001064
	2.4	black	W001065	W001066
Fe, Fc, Mc, Ss, Al, U-groove	1.0	red	W001067	W001068
	1.2	orange	W001069	W001070
	1.6	yellow	W001071	W001072

2.8 INSTALLATION OF WELDING GUN

Make sure the gun wire conduit and the contact tip match the manufacturer's recommendations for the type and diameter of wire you use. Too small a conduit may overload the wire feed device and impede the wire feeding. Tighten the gun's quick connector to eliminate voltage loss. A loose joint will heat up the gun and wire heater.

NOTE! Never use defected gun.

2.9 MOUNTING AND LOCKING OF WIRE REEL

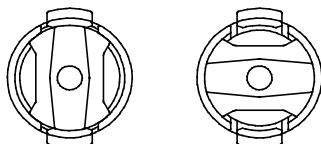

LOCKED

OPEN

- Release locking nails of wire reel hub by turning locking knob a quarter round.
- Mount the reel at its place. Note rotating direction of reel!
- Lock the reel with locking knob, locking nails of hub remain to outside position and will lock the reel.

2.10 AUTOMATIC WIRE FEED TO GUN

Automatic wire feed makes change of wire reel more rapid. In reel change the pressure of feed rolls need not to be released and filler wire goes automatically to correct wire line.

- Make sure that groove of feed roll matches the diameter of welding wire used.
- Release the wire end from reel and cut off the bent length. Be careful that the wire does not spill from the reel to sides!
- Straighten about 20 cm of the wire and see that the end of it has no sharp edges (file off if necessary). A sharp edge may damage the wire guide tube and contact tip of the welding gun.
- Draw a bit of loose wire from wire reel. Feed wire through back liner to feed rolls. Do not release pressure of feed rolls!
- Press the gun switch and feed a bit wire until wire goes through feed rolls to gun. See that wire is in grooves of both feed roll pairs!
- Press still the gun switch until wire has come through contact tip.

Automatic feed may sometimes fail with thin wires (Fe, Fc, Ss: 0,6...0,8 mm, Al: 0,8...1,0 mm). In that case you might have to open feed rolls and feed wire manually through feed rolls.

NOTE! Check that the wire or wire reel does not touch the equipment body, there is a danger of short circuit

2.11 ADJUSTMENT OF PRESSURE

Adjust the pressure of the feed rolls with the control screw so that the wire is fed into the wire guide tube evenly and allows a little braking when emerging from the contact tip, without slipping on the feed rolls.

NOTE! Excessive pressure will cause the filler wire to flatten and damage its coating, as well as undue wear and tear of the feed rolls and friction damage.

2.12 ADJUSTMENT OF TIGHTNESS OF SPOOL BRAKE

Brake force can be adjusted through the hole in the spool hub's locking device of spool hub by screwing the control screw with a screwdriver. Adjust the braking force so that it is sufficient to prevent the wire from becoming too loose on the spool and spilling when the spool stops rotating. The greater the wire feed speed, the greater the braking force required. Do not keep the brake unnecessarily tight, since this will impose a strain on the motor.

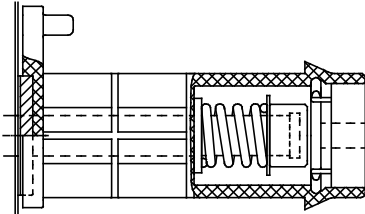

2.13 SHIELDING GAS

The MIG shielding gas consists of carbon dioxide, mixed gases and argon. Shielding gas flow rate is determined by the amount of welding current. The typical flow rate of gas in the welding steel is 8–15 l/min.

Parts of gas flow regulator

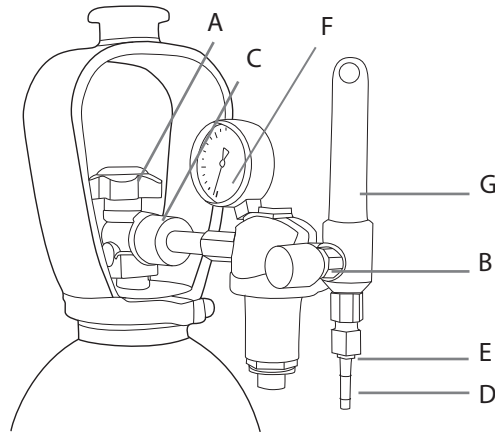

- A. Gas bottle valve
- B. Press regulation screw
- C. Connecting nut
- D. Hose spindle
- E. Jacket nut
- F. Gas bottle pressure meter
- G. Gas hose pressure meter

The following installation instructions are valid for most gas flow regulator types:

1. Step aside and open the bottle valve (A) for a while to blow out possible impurities.
2. Turn the press regulation screw (B) of the regulator until no spring pressure can be felt.
3. Close the needle valve if there is one in the regulator.
4. Install the regulator onto bottle valve and tighten the connecting nut (C) with a wrench.
5. Install the hose spindle (D) and jacket nut (E) into the gas hose and tighten with a hose clamp.
6. Connect the hose with the regulator and the other end with the wire feed unit. Tighten jacket nut.
7. Open the bottle valve slowly. The gas bottle pressure meter (F) shows bottle pressure. **Note!** Do not use the whole contents of the bottle. The bottle pressure should be filled when bottle pressure is 2 bar.
8. Open the needle valve if there is one in the regulator.
9. Turn the regulation screw (B) until the hose pressure meter (G) displays the required flow (or pressure). When regulating the flow amount, the power source should be switched on and the "GAS PURGE" -switch pressed simultaneously.

Close the bottle valve after welding is finished. If the machine will not be in use for a long time, unscrew the pressure regulation screw.

NOTE! Always fasten the gas cylinder securely in an upright position on a wall rack intended for the purpose or on a cylinder cart. Always close the cylinder valve after you have finished welding.

2.14 COOLING UNIT (KEMPACTCOOL 10)

NOTE! Cooling liquid is injurious! Avoid also contact with skin or eyes. In case of injury, seek for medical advice.

Cooling unit KempactCool 10 together with MIG-gun of Kempki's PMT-W and MMT-W range enables MIG welding with water-cooled gun.

The cooling unit is installed beneath the power source with screws and mounting plate.

Electrical connections are on the bottom of power source.

Electrical connection for the cooling unit:

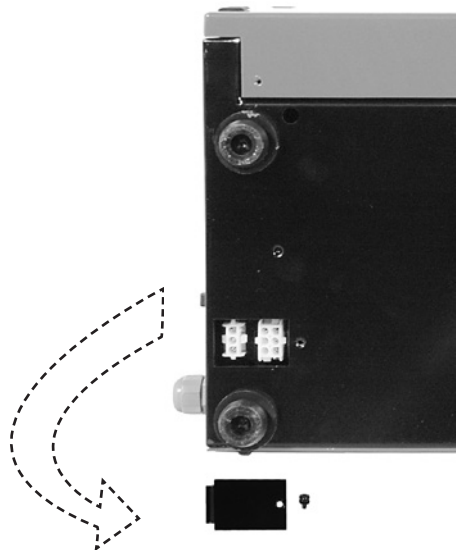

The bottom of power source

1. 400 V
2. Control connector
3. Equipment earth

NOTE! Only an authorised electrician is allowed to install electrical connection!

Installation of cooling unit:

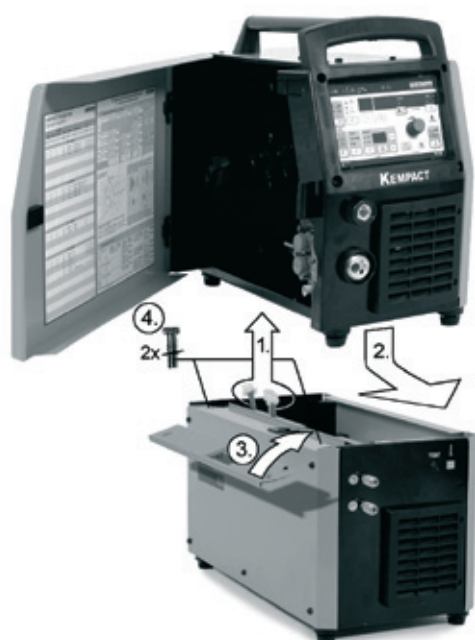

Filling the reservoir:

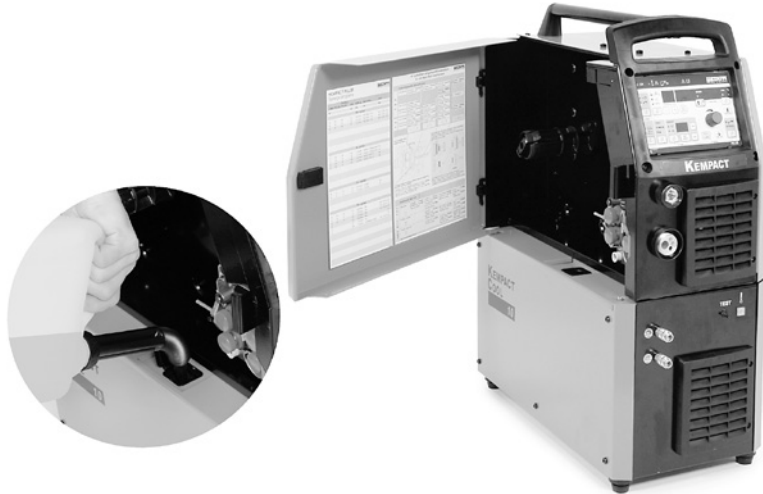

Fill the reservoir with a 20 – 40 % mixture of ethanol and water, or with any other suitable antifreeze. The capacity of the reservoir is 3 litres.

3. OPERATION

3.1 MAIN SWITCH AND SIGNAL LIGHTS

With the switch in the 'I' position, the primary and control circuits of the machine become live and the 'ON' signal light on the panel lights up. The welding circuit receives voltage when the gun switch is operated or when the wire feed test switch is pressed. Always use the main switch to turn the machine on and off with the main switch; do not use the power plug for this purpose.

3.2 TO SELECT POLARITY FOR WELDING

Solid wire is usually welded in the +pole and gasfree filler wires in the - pole gun. When welding with other filler wires, check for the recommended polarity on the package or consult the supplier of the product. The welding of very thin steelplates (0.5 to 0.7 mm) a - polarity might also work best for solid wire.

3.2.1 Changing the polarity



NOTE! Only a service shop authorised by Kemppi may change the polarity.

3.3 PANEL

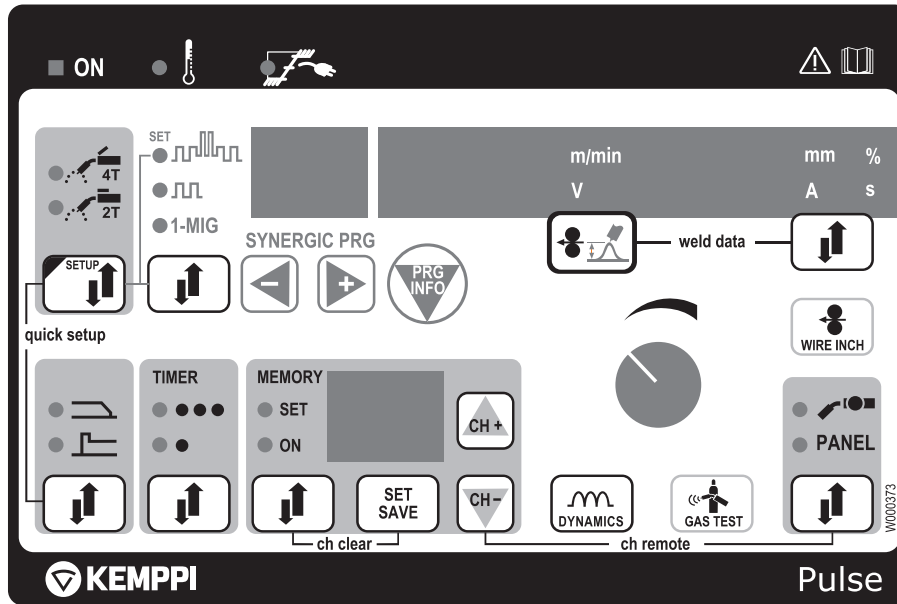

3.3.1 Choosing start switch function



MIG welding by 4-function start switch, MIG 4T
 MIG welding by 2 function start switch, MIG 2T

3.3.2 Choosing the welding method



Normal MIG/MAG welding:

With a separate wire feed and voltage regulation can be chosen in the 1-MIG position. Curve number "00" provides a free wire feed range between 1-18 m/min. The voltage can be set between special pre-programmed limits depending on the wire feed. Curve number "01" wire feed speed and voltage are not depended on each other. When curve "01" is selected, the wire feed speed and voltage will be independent of one another.

Synergic MIG/MAG welding (1-MIG)

Synergic MIG/MAG welding (1-MIG): MIG welding in which the wire feed speed determines all the other welding parameter values, allowing the adjustment of welding power with a single knob. Choose the appropriate synergy curve for the filler wire and shielding gas to determine how the wire feed speed affects the pulse parameters.

Synergic Pulse MIG welding:

through this welding method, based on pulsing the welding current, the filler metal on the workpiece is kept spatter-free. The power source pulse parameters change automatically (synergy) enabling welding power regulation using a single knob. Choose the appropriate

synergy curve for the filler wire and shielding gas to determine how the wire feed speed affects the pulse parameters.

Double pulse:

The wire feed will become higher or lower according to the wire feed range. While the synergic welding parameters change to correspond to the momentary wire speed. The purpose is to get a goodlooking weld and a proper penetration while improving the controllability of the weld pool during position welding.

3.3.3 Selecting 1-MIG/Pulse MIG synergy curves



The program number of the synergy curve is selected using the plus-minus buttons and is displayed on "SYNERGIC PRG".

The middle display is actual material group display (eg. SS, AL, CUS, FE, GEN). Wire diameter (mm) can be seen on the right side. This information will only be displayed for a while.

The "PRG INFO" button gives more curve information:

One press will revert to the material group and diameter display, a second will display the type number of the material and a third run through the gas consistency components one by one.

KEMPACT PULSE 3000 Synergic programs						
1-MIG	Pulse	Double Pulse	Wire, ø	Material	Gas	Wire Feed Range
00			All	All	All	1,0 - 18,0
01			All	All	All	0,5 - 18,0
SS-group						
S1	S1	S1	0,8 mm	SS 308 / 316	Ar + 2 % CO ₂	
S2	S2	S2	0,9 mm	SS 308 / 316	Ar + 2 % CO ₂	
S3	S3	S3	1,0 mm	SS 308 / 316	Ar + 2 % CO ₂	
S4	S4	S4	1,2 mm	SS 308 / 316	Ar + 2 % CO ₂	
S5			0,9 mm	SS 316 FC	Ar + 18 % CO ₂	
S7			1,2 mm	SS 316 FC	Ar + 18 % CO ₂	
Al-group						
A1	A1	A1	1,0 mm	AlMg5 / AlMg4,5Mn	Ar	
A2	A2	A2	1,2 mm	AlMg5 / AlMg4,5Mn	Ar	
A6	A6	A6	1,0 mm	AlSi5 / AlSi12	Ar	
A7	A7	A7	1,2 mm	AlSi5 / AlSi12	Ar	
Cu-group						
C1	C1	C1	0,8 mm	CuSi3	Ar	
C2	C2	C2	0,9 mm	CuSi3	Ar	
C3	C3	C3	1,0 mm	CuSi3	Ar	
C4	C4	C4	1,2 mm	CuSi3	Ar	
C5	C5	C5	0,8 mm	CuAl8	Ar	
C6	C6	C6	0,9 mm	CuAl8	Ar	
C7	C7	C7	1,0 mm	CuAl8	Ar	
C8	C8	C8	1,2 mm	CuAl8	Ar	

Fe-group						
F1	F1	F1	0,8 mm	Fe	Ar + 18 % CO ₂	
F2	F2	F2	0,9 mm	Fe	Ar + 18 % CO ₂	
F3	F3	F3	1,0 mm	Fe	Ar + 18 % CO ₂	
F4	F4	F4	1,2 mm	Fe	Ar + 18 % CO ₂	
F5			0,8 mm	Fe	CO ₂	
F6			0,9 mm	Fe	CO ₂	
F7			1,0 mm	Fe	CO ₂	
F8			1,2 mm	Fe	CO ₂	
FA	FA	FA	1,0 mm	FeMC	Ar + 18 % CO ₂	
FB	FB	FB	1,2 mm	FeMC	Ar + 18 % CO ₂	
FD			1,2 mm	FeFC	Ar + 18 % CO ₂	
Auto						
	20	20	1,0 mm	CuSi3-A	Ar	1,1 – 2,0
1	21	21	1,0 mm	CuSi3-A	Ar	2,0 – 2,6
2	22	22	1,0 mm	CuSi3-A	Ar	2,4 – 3,1
3	23	23	1,0 mm	CuSi3-A	Ar	3,0 – 3,6
4	24	24	1,0 mm	CuSi3-A	Ar	3,5 – 4,1
5	25	25	1,0 mm	CuSi3-A	Ar	4,0 – 4,6
6	26	26	1,0 mm	CuSi3-A	Ar	4,5 – 5,1
7	27	27	1,0 mm	CuSi3-A	Ar	5,0 – 5,5
8	28	28	1,0 mm	CuSi3-A	Ar	5,5 – 6,0
9	29	29	1,0 mm	CuSi3-A	Ar	6,0 – 6,5
10	30	30	1,0 mm	CuSi3-A	Ar	6,4 – 7,0
11	31	31	1,0 mm	CuSi3-A	Ar	6,9 – 7,6
12	32	32	1,0 mm	CuSi3-A	Ar	7,4 – 8,1

3.3.4 Adjustments, display and weld data

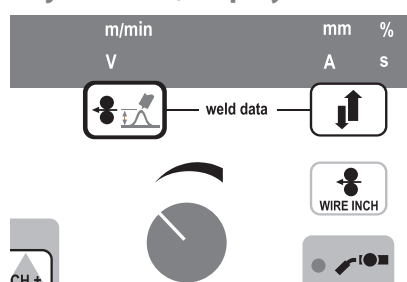

Display for welding current and welding material thickness. Changing can be made using the button behind the display. There is a percentage display (eg. gas consistency) and seconds display (see timer). The relative length of arc will be displayed when adjusted. Otherwise the predicted current value is displayed (not in 2-MIG).

Process Manager™ for setting all welding parameters.

The display for wire feed speed, welding voltage or material group. This can be switched using the button under the display (wire feed speed/length of arc). The voltage can be adjusted in the normal and 1-MIG position (wire feed range/the length of arc). During pulse welding the voltage is determined by the wire feed speed while the length of arc affects some other parameters.

When pressed simultaneously, the weld data buttons recall the wire feed speed on the display, the welding voltage and welding current values which have been used when welding was stopped.

3.3.5 Timer

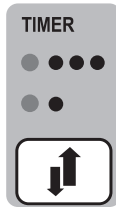

intermittent welding

spot welding

The spot time is set immediately after pressing the switch button, on the display SPt. The pause time is set accordingly, on the PSE display. The time is set using the Process Manager.

3.3.6 Adjustment of welding dynamics



For adjusting of MIG/MAG welding dynamics, the adjustment value dyn -9...0...9 is displayed. The welding stability and quantity of spatter are affected by the welding dynamics control, the 0-position is the recommended reference range. Values -9...-1 give a smoother arc and less spatter, while values 1...9 give a rougher arc and increased stability, when using a 100% CO₂ shielding gas when welding steel.

3.3.7 Remote control



Gun control, wire feed speed or welding power control is changed using RMT 10. Control of the welding voltage or the length of the welding arc can be adjusted using the potentiometer on the panel. Panel control, adjustments using the potentiometer on the panel.

3.3.8 MIG extra functions

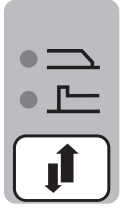

Crater filling, 1-MIG and pulse MIG:

Crater filling reduces welding mistakes caused by end craters. By pressing the 4T-trigger continuously at the end of weld, a descending welding power is achieved which fills end craters in a controlled manner. The descending time is kept constant using the 2T function, and the welding power and end level can be changed using the SETUP-function.

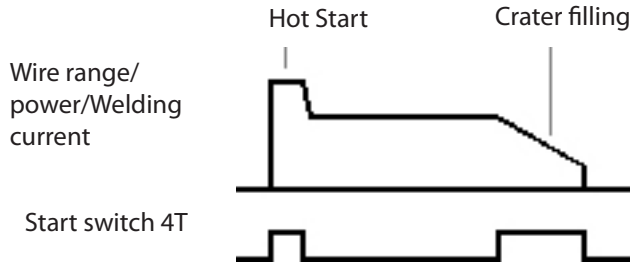

The Hot Start:

The Hot Start function is used with 1-MIG and pulse MIG welding. The Hot Start time by 4T Hot Start time is determined by trigger function (see picture) and while by 2T function it is determined by the SETUP parameters. The level of Hot Start can be changed by SETUP function.

The Hot Start level, Hot Start time by 2T, crater fill level and downslope time can be easily adjusted using the 'QUICK SETUP' function:

1. Select the gun trigger function: 4T or 2T.
2. First, press the SETUP button and then , while still pressing the SETUP button, press the extra function button.
3. Adjust the Hot Start level.
4. Repeat step 2, upon which the display will show the next adjustable parameter, depending on the switch mode.

Exit by pressing any button (except SETUP)

3.3.9 Use of gas test



If you press the gas test button, gas will begin to flow without any starting power source or wire feed. Gas flow can be measured by using an external measuring device.

Cut off the gas flow by pressing the same button again, or the gun trigger. If the trigger is not pressed again, the gas flow will end within 20 seconds.

The display will show "GAS" and the time.

3.3.10 Testing wire feed



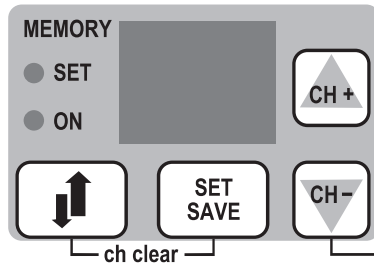

The wire feed switch will start the wire feed motor without opening the gas valve. The power source will start up, but without providing welding power. The wire feed range will be 5m/min but can be adjusted as desired.

3.3.11 Memory channels, MEMORY



The pulse panel has 100 channels for different welding options. Memory channels can be chosen on the lower part of the panel using the memory block. Both welding values and functions can be saved. Do the following:

1. Press  twice if needed and the SET light will start blinking if the channel is not in use, while the light will stay on if the channel is in use.
2. Select the memory channel you want by pressing CH button
3. Make settings and save by pressing SAVE button.
4. Press  twice. ON light turns on.
5. Start welding and set the values.

To change the values, the light must be switched from the ON to SET and then you can choose the parameters, pressing the SAVE button afterwards. It is also possible to save the used parameters by pressing SET when memory function is OFF (no lights). The channel can be

emptied by pressing  and SET button in SET simultaneously.

Using saved settings

1. Press  button.
2. Select the memory channel by pressing the CH button.
3. Start welding.

Memory channels in control device

Select memory channels by pressing the CH REMOTE button simultaneously and the gun control light will start to blink. Use the saved values through the gun's remote control.

You can use five channels.

3.3.12 SETUP

Using the SETUP function, the user can change welding parameters which do not have their own panel functions. These parameters can be set separately for 1-MIG and Pulse MIG. SETUP settings are separate for each memory channel.

Setup functions on pulse panel

Parameter Name	Nr	Display	1-MIG	Pulsed MIG	Factory value	Unit	Explanation
PostGasTime	1	PoG	X	X	Curve	s	PostGas time 0.0 – 9.9 s
PreGasTime	2	PrG	X	X	Curve	s	PreGas time, functions by 2T 0.0 – 9.9 s
HotStartLevel	11	Hot	X	X	30	%	Hot start ratio to welding power -50 ... +75%
HotStartTime 2T	12	H2t	X	X	1.2	s	2T Hot start timer 0.1 – 9.9 s
CraterFillLevel	14	CFL	X	X	30	%	Welding end level 10 – 90 %
CraterFillSlope	15	CFS	X	X	1	s/10m	Wire slowing-down 1 – 20 s/10m
CreepStartLevel	17	CSL	X	X	Syn		Wire speed start value 10 – 90
CreepStartSlope	18	CSS	X	X	0	s/10m	Wire speed up time 0 – 50 s/10m
DoubleFrequency	21	dFr		X	Curve	Hz	Double pulse frequency control 0.4 – 8.0 Hz
DoubleAmpiltude	22	dA		X	Curve	m/min	Double pulse power variation control 0.1 – 3.0 m/min
StartPower	31	StP	X	X	0		Start power control -9 ... 0 ... +9
PulseCurrent	33	PuC		X	0	%	Pulse top current control -10 ... +15%
ArcLength AdjRange	41	ALr	X	X	0	%	Arc length adjustment range -50 ... +75%
Calibration	42	CAL	X	X	1	V/100A	Setting mid value of arc length fine adjustment 0.0 – 10.0 V/100A
WFS	51	FS			18	m/min	Wire feed maximum 18 or 25 m/min
Gun	53	Gun			On		Liquidcooled thermal protection on/off
GunRemote	54	GrE			On		Disabling of gun remote control automatic identification
Water Cooler On/Off Selection	55	Coo			On		Set OFF after each power up if cooler is connected with gas cooled gun.
Display reset time	81	dLY	X	X	5	s	1 – 20 s
PRG INFO - feeld selection	82	diS	X	X	1		1, 2, 3
Restore	99	FAC	X		OFF		Restoring factory settings (OFF=no reset, Pan=panel and setup ALL= also memory channels)

Changing parameters

By pressing the 2T/4T (SETUP) selection switch a little longer the machine will enter the SETUP state. The display will show the set parameter's running number (blinking), its abbreviation and value. Select the parameter number using the "SYNERGIC PRG" + and - buttons or the "SETUP" button (which will jump by tens). Change the value using the control button (in some cases, the value can be found from the synergy curve). "Syn" and the curve value will blink by turns on the right of the display. Set the value by turning the button anticlockwise.

Exit for SETUP using a long press.

Frequency and amplitude of double pulse can be set in the separate 'SET' mode, obtained by first pressing the 2T/4T (SETUP) and, without releasing it, the method button. "dFr" and the frequency in Hz will be displayed. "Syn" will appear if the frequency is based on synergy curves. Change this value by turning the control button anticlockwise. Press it twice to display "dA" i.e. the amplitude (m/min). Adjust this accordingly and exit SETUP by pressing any button other than SETUP.

3.3.13 Error codes

Error codes are among others the following:

Err 3: Overvoltages in the mains supply. Also the pilot light of overvoltage is lighting.

Err 4: The thermal protection of power source has stopped welding. Also the pilot light of thermal protection is lighting.

Err 5: The cooling device has stopped welding.

Err 6: The terminal voltage has risen. Take the device to service.

Err 153: Liquid cooled PMT- or WS-gun is overheated. Or torch-PTC or RMT10 has been installed, but the jumper inside the torch is in FU-position, look also instruction of torch.

Err 154: Overloading of the wire feed motor

Error code is eliminated when the reason is aborted, except Err 6, which demands to turn down the machine.

3.4 COOLING UNIT OPERATION (KEMPACTCOOL 10)



The operation of cooling units KempactCool 10 is controlled by the power source. The cooling unit pump starts automatically when welding starts. Proceed as follows:

- Start power source.
- Check water level and input flow of the reservoir, add liquid if needed.
- If you use a water-cooled gun you can fill it with cooling liquid by pressing TEST-button (on cooling unit).

The pump operates for 5 another minutes after welding has been finished to cool the liquid to the same temperature as in the machine surrounds. This reduces the need of service.

Thermal overload

The thermal overload light is lit, the machine stops and display shows Err 5 when temperature control of the machine has detected cooling water overheating. The cooling unit fan cools down the water, and when the light goes out welding can be started again.

Water flow signal

Display shows Err 5 when water does not flow.

4. MAINTENANCE

4.1 DAILY MAINTENANCE

NOTE! Be careful of mains voltage when handling electric cables!

Clean the wire channel of the gun and check the contact tip regularly. Always check the condition of the mains and welding cable before operation and replace defective cables.

NOTE! Only a qualified electrician should remove or install the mains cable!

4.2 REGULAR MAINTENANCE

Kempki-service workshops sign special service contracts with customers for regular maintenance. All parts are cleaned, checked and if necessary, repaired. The operation of the welding machine is also tested.

5. DISPOSAL OF THE MACHINE



Do not dispose of electrical equipment with normal waste!

In observance of European Directive 2002/96/EC on waste electrical and electronic equipment, and its implementation in accordance with national law, electrical equipment that has reached the end of its life must be collected separately and taken to an appropriate environmentally responsible recycling facility.

The owner of the equipment is obliged to deliver a decommissioned unit to a regional collection centre, per the instructions of local authorities or a Kempki representative. By applying this European Directive you will improve the environment and human health.

6. ORDERING NUMBERS

Item	Ordering number	
Kempact Pulse 3000		621830002
KempactCool 10		6218600
GH 30 Gun holder		6256030
PMT 25	3 m	6252513
PMT 25	4.5 m	6252514
PMT 27	3 m	6252713
PMT 27	4.5 m	6252714
PMT 32	3 m	6253213
PMT 32	4.5 m	6253214
PMT 30W		6253043
PMT 30W		6253044
PMT 35	3 m	6253513
PMT 35	4.5 m	6253514
WS 35	6 m, Al 1.2	6253516A12
WS 35	6 m, Ss 1.0	6253516S10
WS 30W	6 m, Al 1.2	6254206A12
WS 30W	6 m, Ss 1.0	6254206S10
MMT 25	3 m	6252513MMT
MMT 25	4.5 m	6252514MMT
MMT 27	3 m	6252713MMT
MMT 27	4.5 m	6252714MMT
MMT 30W	3 m	6253043MMT
MMT 30W	4.5 m	6253044MMT
Remote Control Unit	RMT 10	6185475
Earth cable 35 mm ²	5 m	6184311
Transport unit ST 7	for power source and gas bottle	6185290
Transport unit P20	power source, cooling unit and gas bottle	6185261
Transport unit P250	power source	6185268
Lift hook		4298180
Gas hose	6 m	W000566
Wire spool pole		4289880
5 kg spool adapter		4251270

Parts of the DuraTorque™ 400 metal feed rolls					
W000731	gear ring 1	driving			2 pcs per unit
W000732	gear ring 2	pressing			2 pcs per unit
W000711	drive ring	V groove	1,2/1,2	optional	4 pcs per unit
W000718	drive ring	V groove	1,0/1,0	optional	4 pcs per unit
W000891	drive ring	V groove	1,0/1,2		4 pcs per unit
9420507	washer		10.5x30x2.5		2 pcs per unit

7. TECHNICAL DATA

Kempact Pulse 3000		
Connection voltage	3~, 50/60Hz	400V ±15%
Rated power	40% ED	12 kVA 250A
	60% ED	10 kVA 207A
	100% ED	7.5 kVA 160A
Supply current	I_{1max}	17 A
	I_{1eff}	11 A
Connection cable	H07RN-F	4G1.5 (5 m)
Fuse (delayed)		16A
Duty cycle 40 °C	40% ED	250A /26.5V
	60% ED	207A /24V
	100% ED	160A /22V
Welding range		8 – 30V
Wire feed speed		1 – 18 m/min
Open circuit voltage		56 V
Power factor at max. current		0.69 (250A / 26V)
Efficiency at max. current		0.84 (250A / 26V)
Filler wires	Fe, Ss	0.6 – 1.2 mm
	Cored wire	0.9 – 1.2 mm
	Al	0.9 – 1.2 mm
	CuSi	0.8 – 1.2 mm
Shielding gas		CO ₂ , Ar, Ar & CO ₂ mixed gases
Wire spool (max. ø)		300 mm (15 kg)
Feed roll ø		32 mm
Thermal class		H (180 °C) / B (130 °C)
External dimensions	LxWxH	580x280x440 mm
Weight		22 kg
Gun connection		EURO
Wire feed mechanism		4 roll
Operating temperature range		- 20 °C ...+ 40 °C
Storage temperature range		- 40 °C ...+ 60 °C
EMC class		A
Degree of protection		IP23S

Cooling unit KempactCool 10		
Operating voltage		400 V - 15% ... 10%
Connection capacity		250 W
Cooling power		1 kW
Start pressure, max		0.4 MPa
Cooling liquid		20% – 40% etanol/water
Tank volume		3 l
External dimensions (LxWxH)		580x280x300 mm
Weight		13 kg
Operating temperature range		- 20 °C ...+ 40 °C
Storage temperature range		- 40 °C ...+ 60 °C
EMC class		A
Degree of protection		IP23S

KEMPPI OY

Kempinkatu 1
PL 13
FIN-15801 LAHTI
FINLAND
Tel +358 3 899 11
Telefax +358 3 899 428
export@kemppi.com
www.kemppi.com

Kotimaan myynti:

Tel +358 3 899 11
Telefax +358 3 734 8398
myynti.fi@kemppi.com

KEMPPI SVERIGE AB

Box 717
S-194 27 UPPLANDS VÄSBY
SVERIGE
Tel +46 8 590 783 00
Telefax +46 8 590 823 94
sales.se@kemppi.com

KEMPPI NORGE A/S

Postboks 2151, Postterminalen
N-3103 TØNSBERG
NORGE
Tel +47 33 346000
Telefax +47 33 346010
sales.no@kemppi.com

KEMPPI DANMARK A/S

Literbuen 11
DK-2740 SKOVLUNDE
DANMARK
Tel +45 4494 1677
Telefax +45 4494 1536
sales.dk@kemppi.com

KEMPPI BENELUX B.V.

Postbus 5603
NL-4801 EA BREDA
NEDERLAND
Tel +31 765717750
Telefax +31 765716345
sales.nl@kemppi.com

KEMPPI (UK) Ltd

Martti Kemppi Building
Fraser Road
Priory Business Park
BEDFORD, MK44 3WH
UNITED KINGDOM
Tel +44 (0)845 6444201
Telefax +44 (0)845 6444202
sales.uk@kemppi.com

KEMPPI FRANCE S.A.S.

65 Avenue de la Couronne des Prés
78681 EPONE CEDEX
FRANCE
Tel +33 1 30 90 04 40
Telefax +33 1 30 90 04 45
sales.fr@kemppi.com

KEMPPI GmbH

Otto-Hahn-Straße 14
D-35510 BUTZBACH
DEUTSCHLAND
Tel +49 6033 88 020
Telefax +49 6033 72 528
sales.de@kemppi.com

KEMPPI SPÓŁKA Z O.O.

Ul. Borzymowska 32
03-565 WARSZAWA
POLAND
Tel +48 22 7816162
Telefax +48 22 7816505
info.pl@kemppi.com

KEMPPI AUSTRALIA PTY LTD.

13 Cullen Place
P.O. Box 5256, Greystanes NSW 2145
SMITHFIELD NSW 2164
AUSTRALIA
Tel. +61 2 9605 9500
Telefax +61 2 9605 5999
info.au@kemppi.com

ООО КЕМППИ

Polkovaya str. 1, Building 6
127018 MOSCOW
RUSSIA
Tel +7 495 739 4304
Telefax +7 495 739 4305
info.ru@kemppi.com

ООО КЕМППИ

ул. Полковоя 1, строение 6
127018 Москва
Tel +7 495 739 4304
Telefax +7 495 739 4305
info.ru@kemppi.com

KEMPPI, TRADING (BEIJING) COMPANY, LIMITED

Room 420, 3 Zone, Building B,
No.12 Hongda North Street,
Beijing Economic Development Zone,
100176 Beijing
CHINA
Tel +86-10-6787 6064
+86-10-6787 1282
Telefax +86-10-6787 5259
sales.cn@kemppi.com
肯倍贸易 (北京) 有限公司
中国北京经济技术开发区宏达北路12号
创新大厦B座三区420室 (100176)
电话 : +86-10-6787 6064
+86-10-6787 1282
传真 : +86-10-6787 5259
sales.cn@kemppi.com

KEMPPI INDIA PVT LTD

LAKSHMI TOWERS
New No. 2/770,
First Main Road,
KAZURA Gardens,
Neelangarai,
CHENNAI - 600 041
TAMIL NADU
Tel +91-44-4567 1200
Telefax +91-44-4567 1234
sales.india@kemppi.com